

Data Sheet

Relative Capacitive Level Sensor

SCS-1001-00

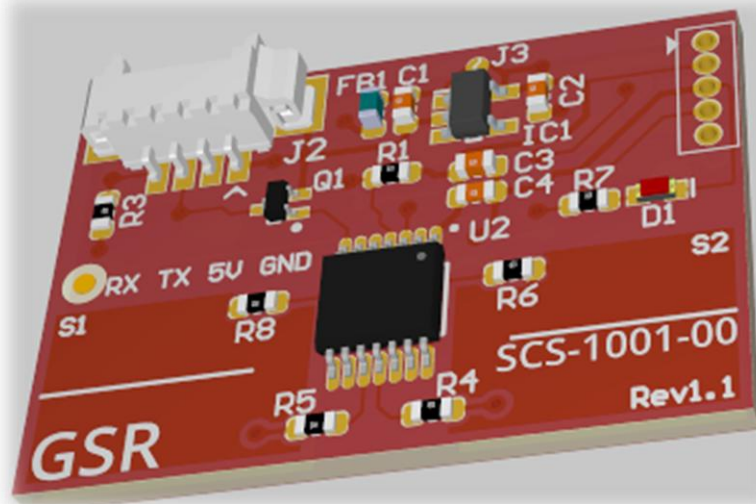

Version	1.0
Data	01/02/2025

Revision History

Revision	Data	Description
1.0	01/02/2025	First draft

GSR Technology Italy contacts

Contact	contact@gsr-technology.it	+39 0362 154 5399
---------	--	-------------------

SCS-1001-00 – Capacitive Sensor

Plug-in, low cost, high sensitivity, superior noise immunity capacitive sensor for embedded applications.

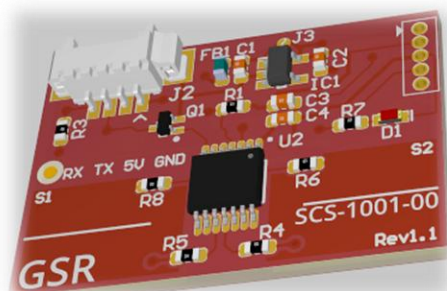

The SCS-1001-00 sensor is designed to detect a limit level of a liquid, bulk-solid and powder materials enclosed in NOT conductive containers, silos, vessels, tanks, filling inlets, reservoirs, etc. The sensor does not require to be in direct contact with the media under measurement and typically can be mounted externally to the containers (NOT metallic neither conductive). Thanks to its smart and advanced technology based on the electric field analysis, the sensor has a superior sensitivity and very high noise immunity compared to classical solutions realized by capacitive sensing.

Standard Operating Conditions

	Min	Typ	Max	Unit
Supply Voltage	3.7	5	5.5 ⁽¹⁾	V
Supply Current	-	2.5	3	mA
Temp. Range	0		85	°C
Output Signal	-	Open Collector	-	
Sensor Size	-	30 x 20 x 3.6 ⁽²⁾	-	mm
Type of connector	Molex PicoBlade 53261-0471 ⁽³⁾			
Fixing and installation	Mechanical tracks, Dual Side Tape, Silicone or Epoxy resin			

(1) A version compatible with input voltages up to 30V is available upon request

(2) 1.6mm is the PCB thickness, 3.6 mm is the thickness considering components connector excluded

(3) Match with Molex PicoBlade 51021-0400

Typical application

The sensor is suitable for Home Appliance, Home Automation and Industrial application.

Main features	Typical applications
<ul style="list-style-type: none"> ➤ High reliability ➤ Very high sensitivity ➤ Superior immunity to electrical noise ➤ Temperature stability due to internal compensation ➤ One shot calibration ➤ No need of direct contact between the sensor and the media 	<ul style="list-style-type: none"> ➤ Home appliances <ul style="list-style-type: none"> • Water level sensor for coffee machines • Coffee Grain presence • Water level sensor for dryer • Water level sensor for steam oven • Liquid inside tanks in general ➤ Home automation <ul style="list-style-type: none"> • Rain sensor • Closure switch • Spas, bathtubs ➤ Industrial <ul style="list-style-type: none"> • Floor cleaning machines water level sensor • Material detection in silos • Grain detection

Pin Out Connections

At each power-on, the OUT pin is managed in open-collector as a digital OFF/ON signal (0-Vin) to indicate that the value read by the sensor is above/below the threshold.

The UART RX pin is always active and is responsible for transmitting commands to the sensor. Through the CHG Mode command on the UART RX pin, it is possible to change the operating mode between open-collector output and serial output: the UART operates at 115200, 8n1.

In serial output mode, the sensor uses the UART TX pin to send periodic feedback on the detection status of the level sensor.

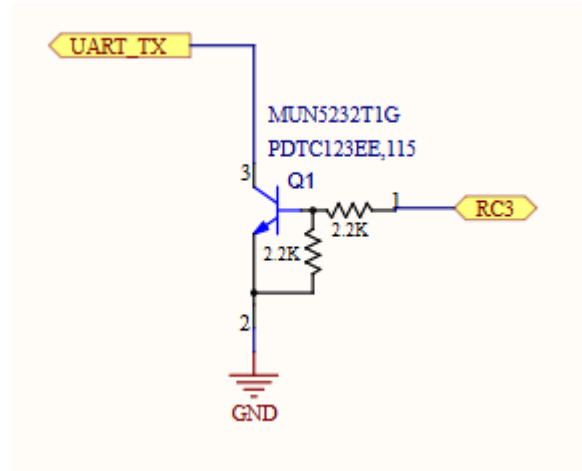
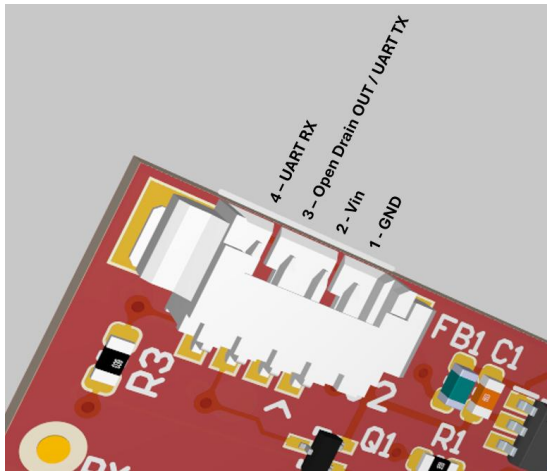

Typical Use case: Water Level Sensor

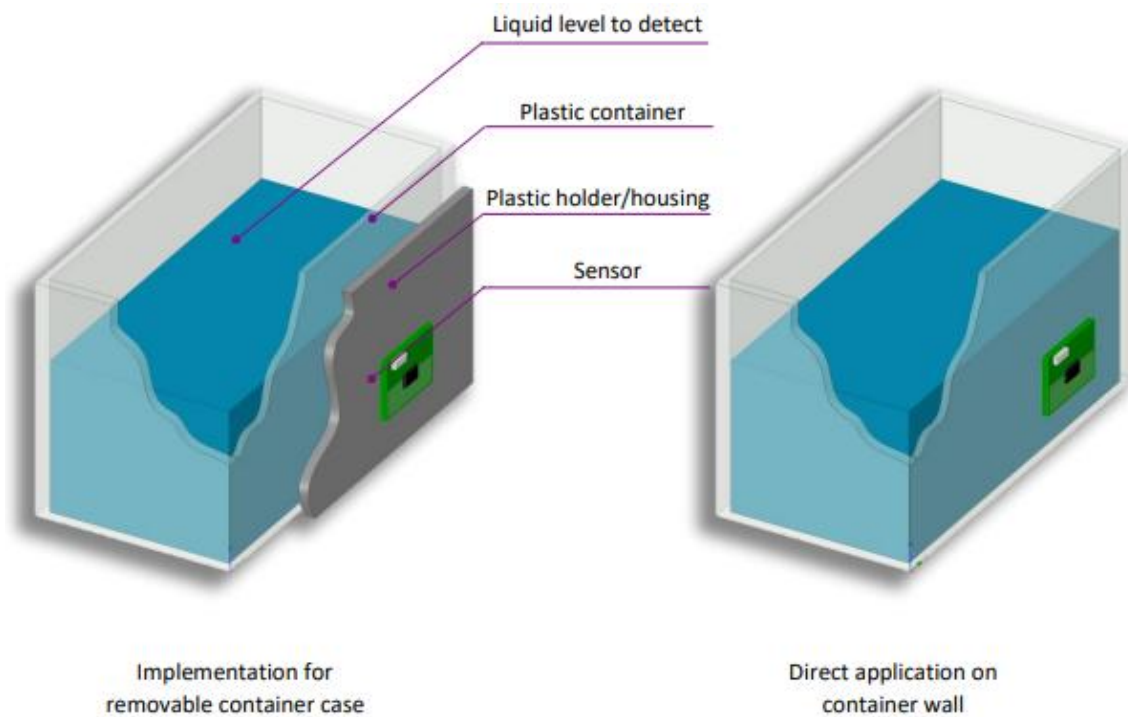

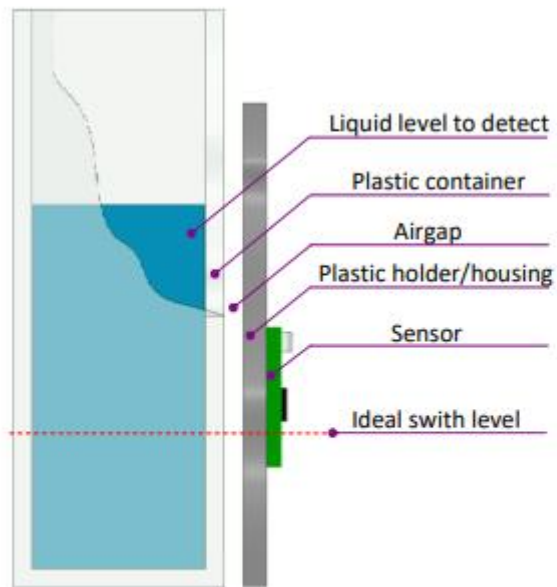

Implementation for
removable container case
Stack-up view

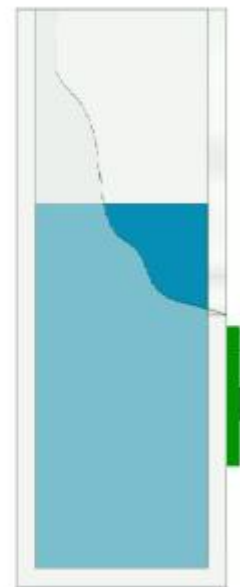

Direct application on
container wall
Stack-up view

GSR

your embedded partner



GSR Technology Italy

via Laboratori Autobianchi, 1 – Strada 10, Building 22

20832 Desio (MB) - Italy

Telefono: +39 0362 154 5399

e-mail : contact@gsr-technology.it